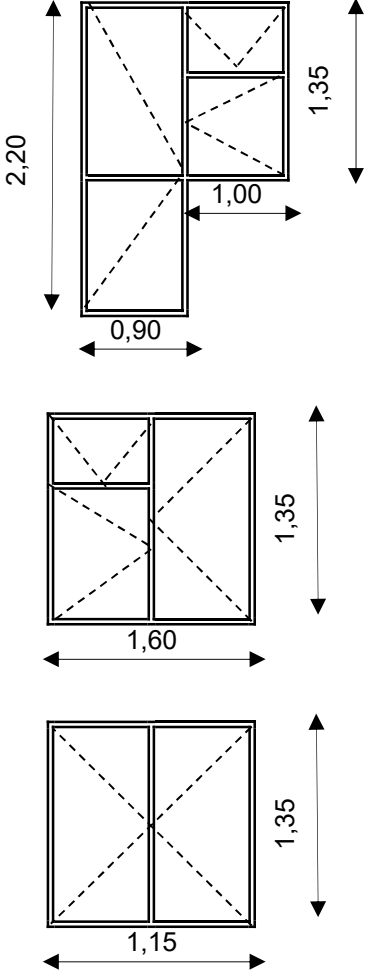
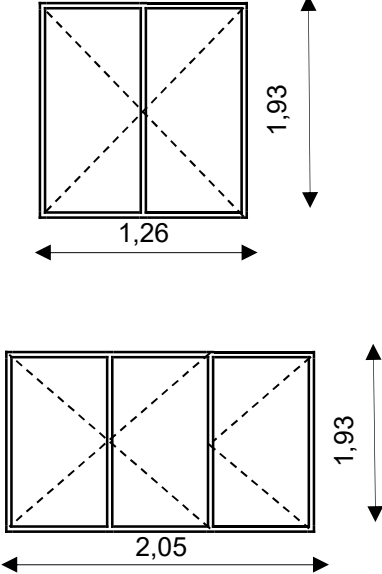
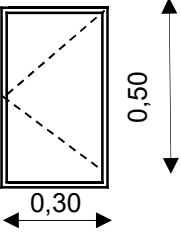
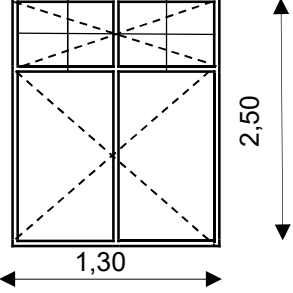
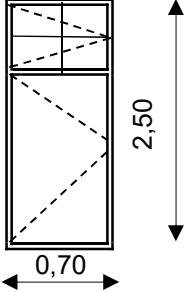
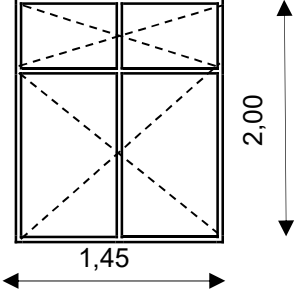
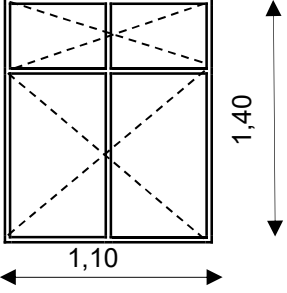

**WYKAZ STOLARKI OKIENNEJ PRZEWIDZIANEJ DO WYMIANY**

**Uwaga! Podane wymiary są wymiarami w świetle ościeży wewnętrznych - większość stolarki przewidzianej do wymiany jest typu skrzynkowego**

Lp.	Adres,	Szkic okna	Ilość szt./ m <sup>2</sup>
1.	UL. 3 Maja 19		
	m 25		szt. - 1 3,33 m <sup>2</sup>  szt. - 1 2,16 m <sup>2</sup>  szt. - 1 1,55 m <sup>2</sup> nawiewnik szt. - 1
2.	AL. WOJSKA POLSKIEGO 181		
	m 2		szt. - 1 2,43 m <sup>2</sup> nawiewnik szt. - 1  szt. - 2 7,90 m <sup>2</sup>

Lp.	Adres	Szkic okna	Ilość szt./ m <sup>2</sup>
c.d	AL. WOJSKA POLSKIEGO 181		
	m 2		szt. - 1 0,15 m <sup>2</sup>  nawiewnik szt. - 1
3.	UL. BROWARNA 3		
	m 4	 	szt. - 1 3,25 m <sup>2</sup>  szt. - 2 3,50 m <sup>2</sup>
4.	UL. CIASNA 21		
	m 20		szt. - 1 2,90 m <sup>2</sup>
5.	UL. CMENTARNA 14		
	m 13		szt. - 2 3,08 m <sup>2</sup>  nawiewnik szt. - 1

Lp.	Adres	Szkic okna	Ilość szt./ m <sup>2</sup>
<b>6</b>	<b>Dobrzecka 23</b>		
	m 8		szt. - 2 3,20 m <sup>2</sup>  nawiewnik szt. - 1
<b>7.</b>	<b>UL. GARNCARSKA 14</b>		
	m 2		szt. - 3 6,66 m <sup>2</sup>
<b>8.</b>	<b>UL. HARCERSKA 15</b>		
	m 7		szt. - 2 5,07 m <sup>2</sup>  nawiewnik szt. - 1
<b>9.</b>	<b>UL. HOŻA 16</b>		
	m 30	<p>drzwi balkonowe</p>	szt. - 1 1,98 m <sup>2</sup>          szt. - 1 1,80 m <sup>2</sup>

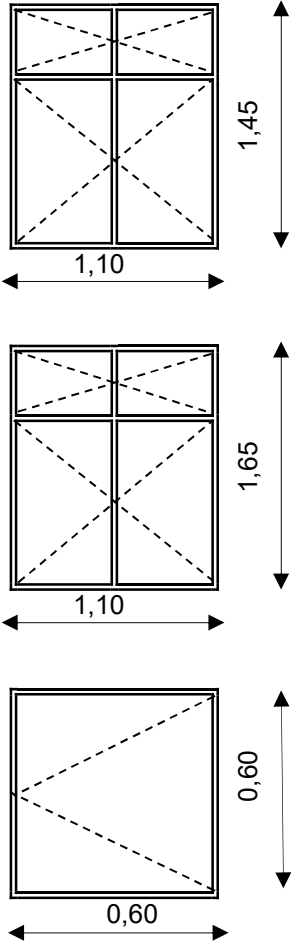
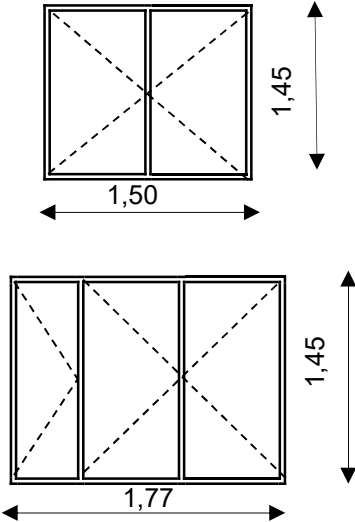
Lp.	Adres	Szkic okna	Ilość szt./ m <sup>2</sup>
10.	UL. JABŁKOWSKIEGO 18  m 1-3		szt. - 2 3,19 m <sup>2</sup>  nawiewnik szt. - 1  szt. - 2 3,63 m <sup>2</sup>  szt. - 1 0,36 m <sup>2</sup>  nawiewnik szt. - 1
11.	UL. JOSELEWICZA 2A  m 13		szt. - 2 4,35 m <sup>2</sup>  nawiewnik szt. - 1  szt. - 1 2,57 m <sup>2</sup>

Lp.	Adres	Szkic okna	Ilość szt./ m <sup>2</sup>
12.	<b>UL. KANONICKA 8</b>		
	m 11		szt. - 3 5,40 m <sup>2</sup>
13.	<b>UL. LUBELSKA 29-33</b>		
	m 16		szt. - 2 3,60 m <sup>2</sup> nawiewnik szt. - 1
14.	<b>UL. ŁAZIENNA 9</b>		
	m 10		szt. - 2 4,80 m <sup>2</sup> nawiewnik szt. - 1
15.	<b>UL. OSTROWSKA 13</b>		
	m 7		szt. - 3 7,02 m <sup>2</sup> nawiewnik szt. - 1
16.	<b>UL. PARCZEWSKIEGO 7</b>		
	m 1		szt. - 4 7,68 m <sup>2</sup>

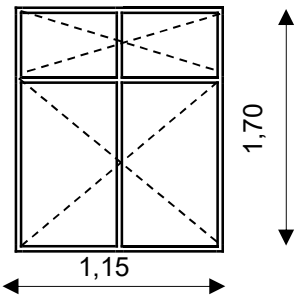
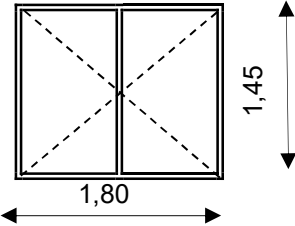
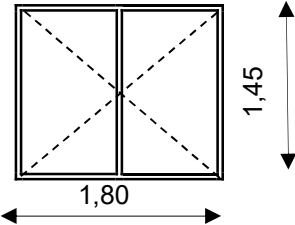
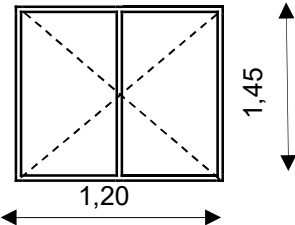
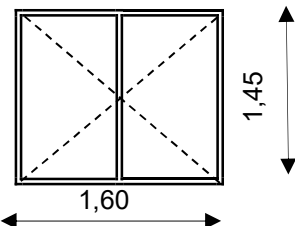
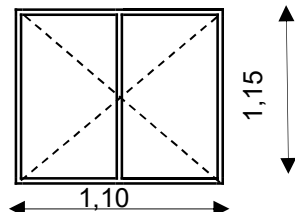
Lp.	Adres	Szkic okna	Ilość szt./ m <sup>2</sup>
17.	UL. PODGÓRZE 14		
	m 3a		szt. - 4 7,82 m <sup>2</sup>  nawiewnik szt. - 1
18.	UL. POŁUDNIOWA 64a		
	m 12		szt. - 1 2,61 m <sup>2</sup>
19.	UL. POŁUDNIOWA 64a		
	m 36	  	szt. - 1 2,61 m <sup>2</sup>  szt. - 1 1,74 m <sup>2</sup>  nawiewnik szt. - 1  szt. - 1 2,32 m <sup>2</sup>
20.	UL. POZNAŃSKA 3		
	m 6		szt. - 4 5,06 m <sup>2</sup>

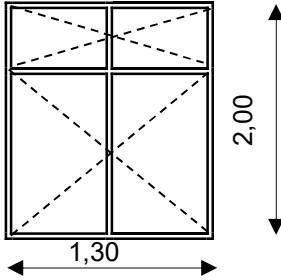
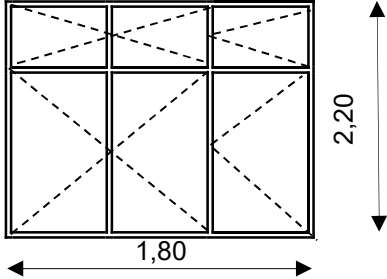
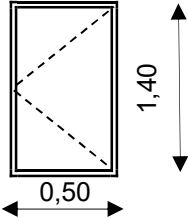
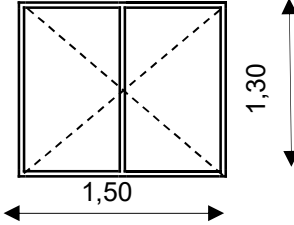
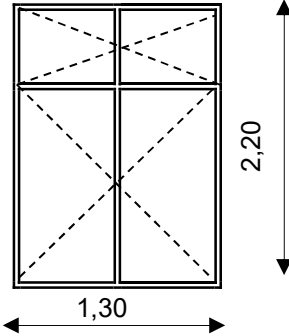
Lp.	Adres	Szkic okna	Ilość szt./ m <sup>2</sup>
<b>21.</b>	<b>UL. PUŁASKIEGO 5</b>		
	m 1		szt. - 3 7,90 m <sup>2</sup>
	m 16		szt. - 1 3,96 m <sup>2</sup> nawiewnik szt. - 1
<b>22.</b>	<b>UL. PUŁASKIEGO 14</b>		
	m 2a		szt. - 1 0,70 m <sup>2</sup> nawiewnik szt. - 1
<b>23.</b>	<b>UL. TORUŃSKA 8</b>		
	m 11		szt. - 1 1,95 m <sup>2</sup>
<b>24.</b>	<b>UL. WODNA 2</b>		
	m 17		szt. - 2 5,72 m <sup>2</sup>

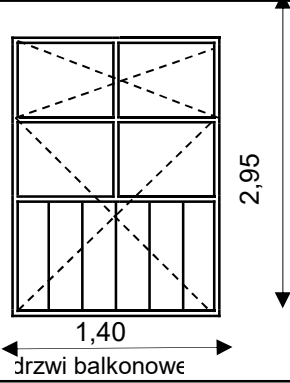
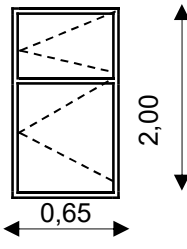
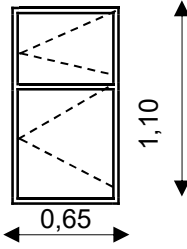
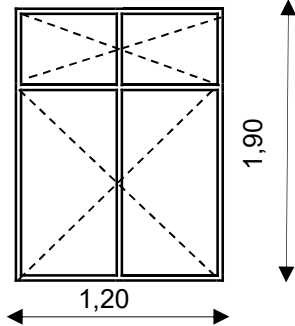
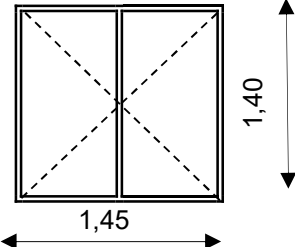
Lp.	Adres	Szkic okna	Ilość szt./ m <sup>2</sup>
c.d			
24.	UL. WODNA 2		
			szt. - 1 4,13 m <sup>2</sup>
25.	UL. ZAMKOWA 5		
	m 2 (od podwórza)	  	szt. - 1 1,30 m <sup>2</sup>  nawiewnik szt. - 1  szt. - 2 1,43 m <sup>2</sup>  nawiewnik szt. - 2  szt. - 2 4,56 m <sup>2</sup>  nawiewnik szt. - 2
26.	UL. ŻŁOTA 37A		
	m 24		szt. - 2 4,06 m <sup>2</sup>  nawiewnik szt. - 1

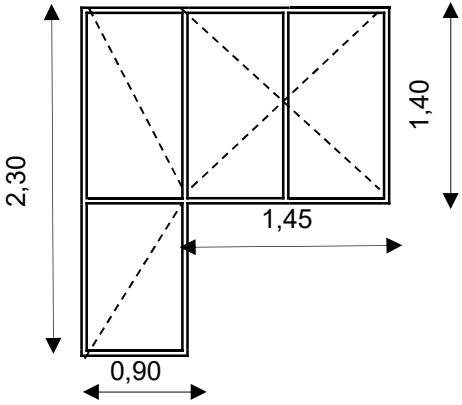
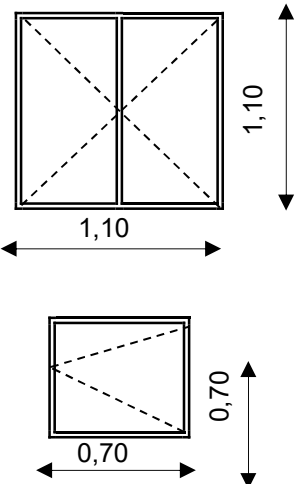
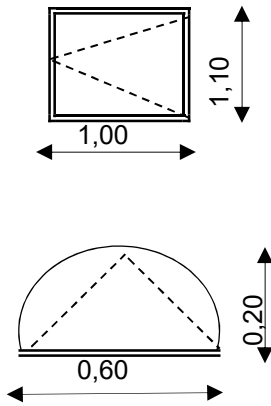

Lp.	Adres	Szkic okna	Ilość szt./ m <sup>2</sup>
c.d			
26.	UL. ŻŁOTA 37A		szt. - 1 4,10 m <sup>2</sup>
27.	UL. ŻŁOTA 41		szt. - 1 1,21 m <sup>2</sup>  szt. - 1 0,49 m <sup>2</sup> nawiewnik szt. - 1
28.	UL. ŻWIRKI I WIGURY 3		szt. - 4 4,40 m <sup>2</sup>  szt. - 1 0,12 m <sup>2</sup>

Łączna ilość stolarki przewidzianej do wymiany :	<b>80 szt.</b> <b>159,66 m<sup>2</sup></b>
Przewidywana ilość parapetów wewnętrznych :	<b>77 szt.</b> <b>110,43 mb</b>
Przewidywana ilość parapetów zewnętrznych :	<b>77 szt.</b> <b>110,43 mb</b>
Przewidywana ilość nawiewników powietrza :	<b>23 szt.</b>