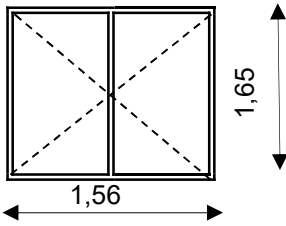
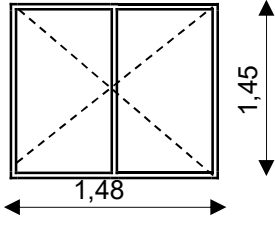
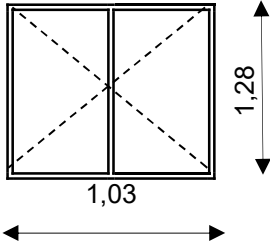
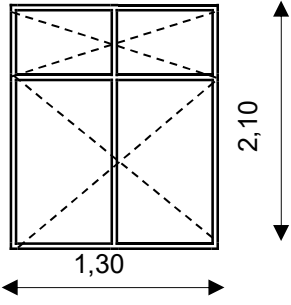
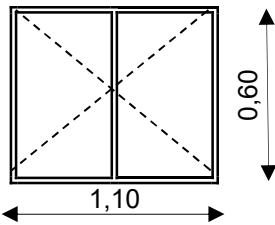

**WYKAZ STOLARKI OKIENNEJ PRZEWIDZIANEJ DO WYMIANY**

**Uwaga! Podane wymiary są wymiarami w świetle ościeży wewnętrznych - większość stolarki przewidzianej do wymiany jest typu skrzynkowego**

Lp.	Adres	Szkic okna	Ilość szt./ m <sup>2</sup>
1.	AL. WOJSKA POLSKIEGO 110		
m 3			szt. - 2 3,08 m <sup>2</sup>
2.	ASNYKA 5		
m 3-4			szt. - 4 6,51 m <sup>2</sup>  nawiewnik szt. - 1
3.	BABINA 10		
m 1			szt. - 3 13,50 m <sup>2</sup>  nawiewnik szt. - 1
m 5			szt. - 2 10,44 m <sup>2</sup>
m 6			szt. - 1 5,22 m <sup>2</sup>  nawiewnik szt. - 1

Lp.	Adres	Szkic okna	Ilość szt./ m <sup>2</sup>
<b>c.d 3.</b>	<b>BABINA 10</b>		
	m 6		szt. - 1 6,29 m <sup>2</sup>  szt. - 1 5,13 m <sup>2</sup>
<b>4.</b>	<b>BABINA 18</b>		
	m 6		szt. - 1 4,06 m <sup>2</sup>  szt. - 1 2,08 m <sup>2</sup> nawiewnik szt. - 1  szt. - 1 0,88 m <sup>2</sup> nawiewnik szt. - 1
<b>5.</b>	<b>BANKOWA 7</b>		
	m 14		szt. - 3 8,16 m <sup>2</sup>  nawiewnik szt. - 1

Lp.	Adres	Szkic okna	Ilość szt./ m <sup>2</sup>
<b>6.</b>	<b>BANKOWA 9</b>		
	m 14		szt. - 5 12, 87 m <sup>2</sup>  nawiewnik szt. - 1
<b>7.</b>	<b>UL. BERKA JOSELEWICZA 2A</b>		
	m 21		szt. - 3 6,44 m <sup>2</sup>
<b>8.</b>	<b>UL. BOLESŁAWA POBOŻNEGO 43</b>		
	m 11		szt. - 4 5,27 m <sup>2</sup>  nawiewnik szt. - 1
<b>9.</b>	<b>UL. BROWARNA 8</b>		
	m 11A		szt. - 3 8,19 m <sup>2</sup>
<b>10.</b>	<b>UL. CIASNA 12</b>		
	m 13-14		szt. - 2 1,32 m <sup>2</sup>

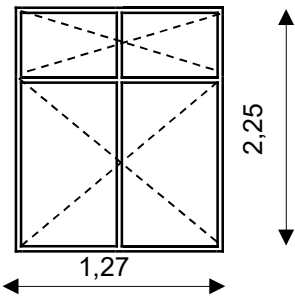
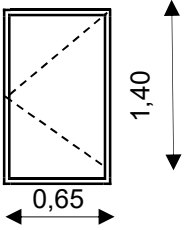
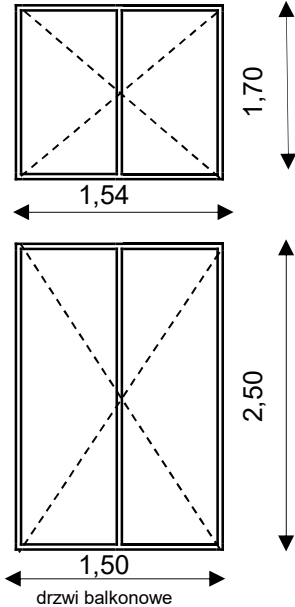
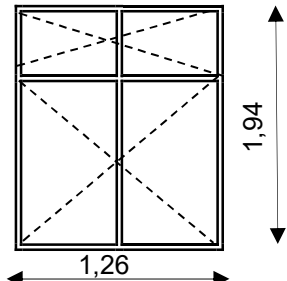
Lp.	Adres	Szkic okna	Ilość szt./ m <sup>2</sup>
11.	<b>UL. CZASZKOWSKA 14</b>		
	m 4		szt. - 3 8,57 m <sup>2</sup>
12.	<b>UL. CZĘSTOCHOWSKA 13</b>		
	m 9 i 9A (wspólne WC)		szt. - 1 0,91 m <sup>2</sup>  nawiewnik szt. - 1
13.	<b>UL. DOBRZECKA 62B</b>		
	m 18		szt. - 2 5,24 m <sup>2</sup>  nawiewnik szt. - 1  szt. - 1 3,75 m <sup>2</sup>
14.	<b>UL. GARNCARSKA 18</b>		
	m 2		szt. - 5 12,22 m <sup>2</sup>  nawiewnik szt. - 1

Lp.	Adres	Szkic okna	Ilość szt./ m <sup>2</sup>
c.d 14.	<b>UL. GARNCARSKA 18</b>		
	m 2		szt. - 2 2,91 m <sup>2</sup>  nawiewnik szt. - 2
<b>15.</b>	<b>UL. GDYŃSKA 6</b>		
	m 10		szt. - 5 8,14 m <sup>2</sup>  nawiewnik szt. - 1
<b>16.</b>	<b>UL. GOŁĘBIA 1</b>		
	m 8		szt. - 1 1,35 m <sup>2</sup>  nawiewnik szt. - 1
<b>17.</b>	<b>UL. GÓRNOŚLĄSKA 6</b>		
	m 4a		szt. - 1 1,14 m <sup>2</sup>  nawiewnik szt. - 1
	m 8		szt. - 1 2,22 m <sup>2</sup>  nawiewnik szt. - 1

Lp.	Adres	Szkic okna	Ilość szt./ m <sup>2</sup>
c.d 17.	<b>UL. GÓRNOŚLAŚKA 6</b>		
			szt. - 1 2,66 m <sup>2</sup>
<b>18.</b>	<b>UL. GÓRNOŚLAŚKA 31</b>		
	m 16		szt. - 3 0,90 m <sup>2</sup>  nawiewnik szt. - 2
<b>19.</b>	<b>UL. GÓRNOŚLAŚKA 59</b>		
	m 58		szt. - 2 4,76 m <sup>2</sup>  nawiewnik szt. - 1
<b>20.</b>	<b>UL. GÓRNOŚLAŚKA 59 A</b>		
	m 65		szt. - 1 2,31 m <sup>2</sup>  nawiewnik szt. - 1
<b>21.</b>	<b>UL. GÓRNOŚLAŚKA 63 A</b>		
	m 27	 	szt. - 1 3,57 m <sup>2</sup>  szt. - 1 1,19 m <sup>2</sup>  nawiewnik szt. - 1

Lp.	Adres	Szkic okna	Ilość szt./ m <sup>2</sup>
22.	UL. GRANICZNA 45		
	m 7		szt. - 1 0,88 m <sup>2</sup>  nawiewnik szt. - 1  szt. - 1 2,09 m <sup>2</sup>  szt. - 1 2,84 m <sup>2</sup>
23.	UL. GRODZKA 3		
	m 4a		szt. - 3 7,38 m <sup>2</sup>  nawiewnik szt. - 1
24.	UL. HANDLOWA 28		
	m 11		szt. - 3 7,38 m <sup>2</sup>  nawiewnik szt. - 1

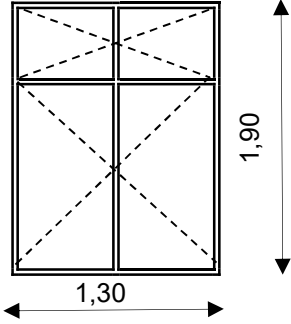
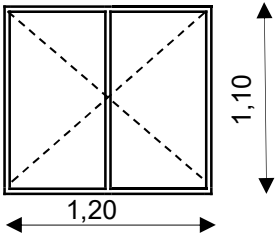
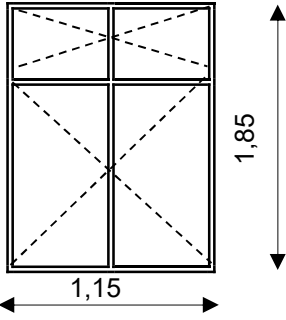
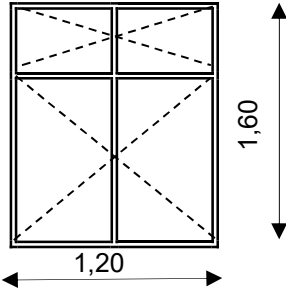
Lp.	Adres	Szkic okna	Ilość szt./ m <sup>2</sup>
25.	UL. HARCERSKA 15		
	m 10		szt. - 1 2,47 m <sup>2</sup>
26.	UL. HOŻA 5		
	m 6		szt. - 3 3,96 m <sup>2</sup>
27.	UL. JABŁKOWSKIEGO 10		
	m 13		szt. - 4 8,51 m <sup>2</sup>  nawiewnik szt. - 1
28.	UL. JABŁKOWSKIEGO 18		
	m 6		szt. - 2 3,84 m <sup>2</sup>

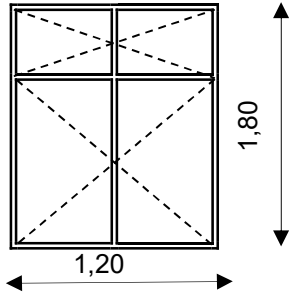
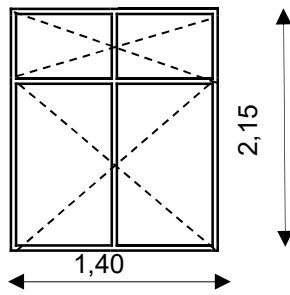
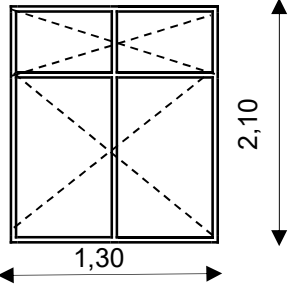
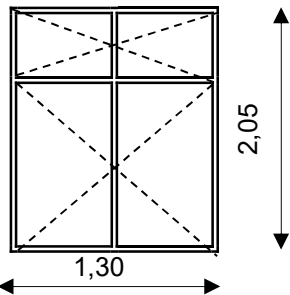
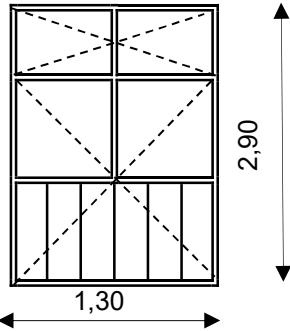

Lp.	Adres	Szkic okna	Ilość szt./ m <sup>2</sup>
c.d			
28.	UL. JABŁKOWSKIEGO 18		
m 6			szt. - 2 4,20 m <sup>2</sup>  szt. - 1 1,65 m <sup>2</sup>  nawiewnik szt. - 1
29.	UL. JABŁKOWSKIEGO 20		
m 3A			szt. - 1 1,65 m <sup>2</sup>  szt. - 1 2,40 m <sup>2</sup>  nawiewnik szt. - 1
30.	UL. JABŁKOWSKIEGO 22		
m 5			szt. - 3 7,02 m <sup>2</sup>  nawiewnik szt. - 1

Lp.	Adres	Szkic okna	Ilość szt./ m <sup>2</sup>
<b>31.</b>	<b>UL. KOPERNIKA 9</b>		
	m 6		szt. - 3 6,48 m <sup>2</sup>  nawiewnik szt. - 1
<b>32.</b>	<b>UL. KOŚCIUSZKI 14</b>		
	m 8		szt. - 2 6,02 m <sup>2</sup>  nawiewnik szt. - 1
	m 13		szt. - 1 2,73 m <sup>2</sup>  nawiewnik szt. - 1
<b>33.</b>	<b>UL. LEGIONÓW 12</b>		
	m 7		szt. - 2 5,33 m <sup>2</sup>
		 <p>drzwi balkonowe</p>	szt. - 1 3,77 m <sup>2</sup>

Lp.	Adres	Szkic okna	Ilość szt./ m <sup>2</sup>
34.	UL. LIPOWA 24		
m 7			szt. - 3 6,30 m <sup>2</sup>  nawiewnik szt. - 1
35.	UL. LOTNICZA 2		
m 4			szt. - 3 4,86 m <sup>2</sup>  nawiewnik szt. - 1
36.	UL. ŁÓDZKA 14		
m 3			szt. - 2 3,74 m <sup>2</sup>  nawiewnik szt. - 1
37.	UL. MICKIEWICZA 1		
m 37			szt. - 1 1,08 m <sup>2</sup>  nawiewnik szt. - 1  szt. - 3 6,96 m <sup>2</sup>  szt. - 1 3,12 m <sup>2</sup>

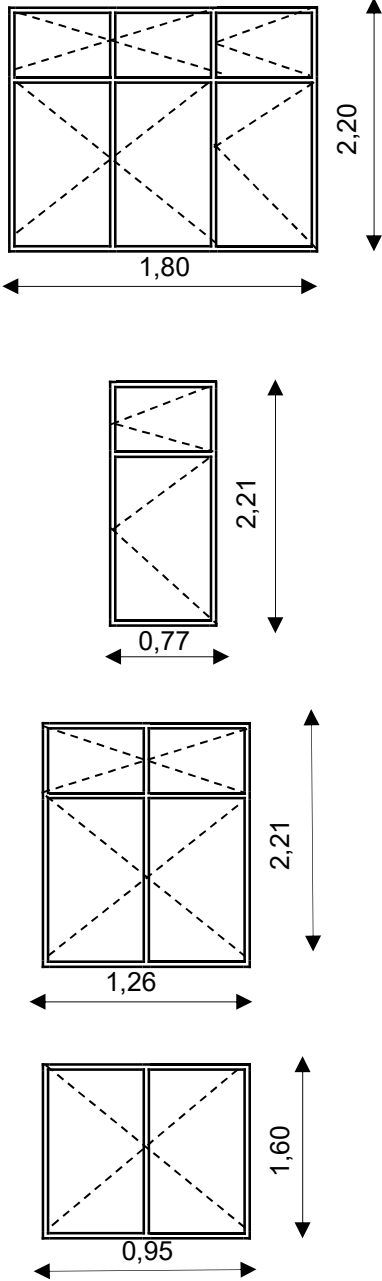
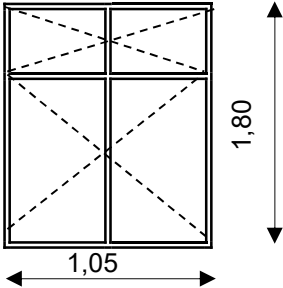
Lp.	Adres	Szkiec okna	Ilość szt./ m <sup>2</sup>
38.	UL. NOWY ŚWIAT 2  m 15	 <p>The sketches show four window types: a 1,80 x 2,20 m window with a top transom; a narrow 0,77 x 2,21 m window; a 1,26 x 2,21 m window with a top transom; and a 0,95 x 1,60 m window.</p>	szt. - 1 3,96 m <sup>2</sup>  szt. - 1 1,70 m <sup>2</sup>  szt. - 1 2,78 m <sup>2</sup>  szt. - 1 1,52 m <sup>2</sup> nawiewnik szt. - 1
39.	UL. OGRODOWA 16  m 2	 <p>The sketch shows a 1,05 x 1,80 m window with a top transom.</p>	szt. - 3 5,67 m <sup>2</sup>  nawiewnik szt. - 1

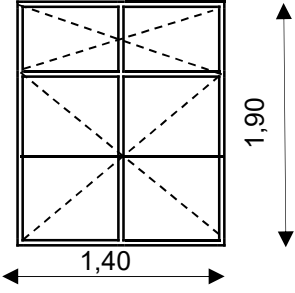
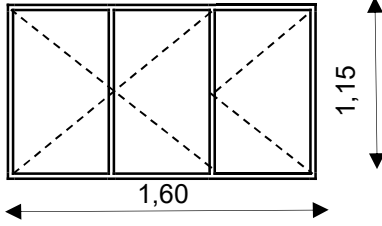
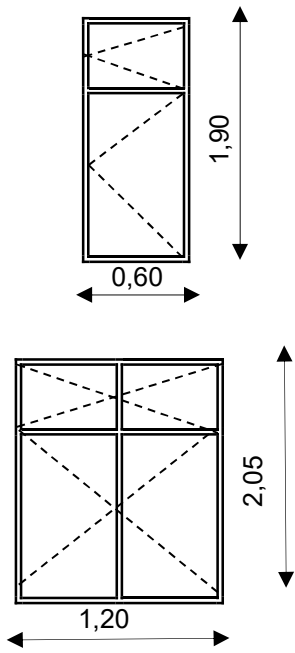
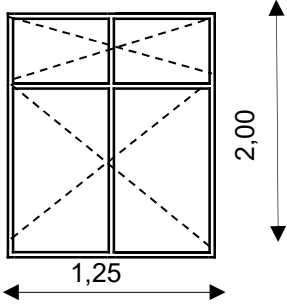
Lp.	Adres	Szkic okna	Ilość szt./ m <sup>2</sup>
40.	UL. PIEKARSKA 8		
	m 9		szt. - 1 2,66 m <sup>2</sup>
41.	UL. PISKORZEWIE 15		
	m 8		szt. - 1 1,84 m <sup>2</sup>
42.	UL. PISKORZEWSKA 3		
	m 4		szt. - 1 1,14 m <sup>2</sup>  szt. - 1 2,46 m <sup>2</sup>
43.	UL. PISKORZEWSKA 14		
	m 2		szt. - 3 7,50 m <sup>2</sup>

Lp.	Adres	Szkic okna	Ilość szt./ m <sup>2</sup>
c.d			
43.	UL. PISKORZEWSKA 14		
	m 2		szt. - 1 1,50 m <sup>2</sup>  nawiewnik szt. - 1
44.	UL. PODGÓRZE 12		
	m 2		szt. - 5 12,00 m <sup>2</sup>  nawiewnik szt. - 1
45.	UL. PODMIEJSKA 5		
	m 28		szt. - 1 4,27 m <sup>2</sup>  nawiewnik szt. - 1
			szt. - 1 2,94 m <sup>2</sup>
	m 66		szt. - 1 4,13 m <sup>2</sup>
			szt. - 1 2,80 m <sup>2</sup>

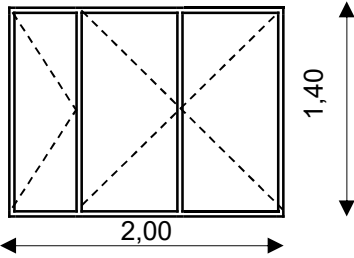
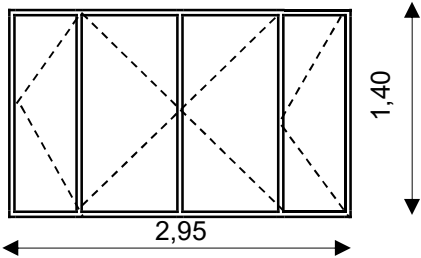
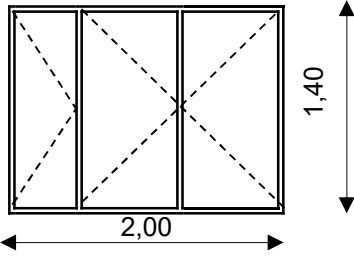
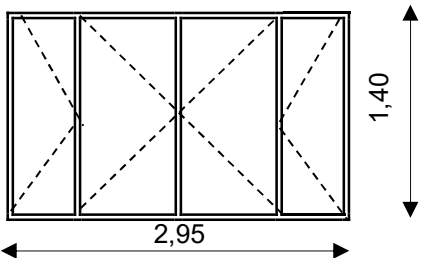
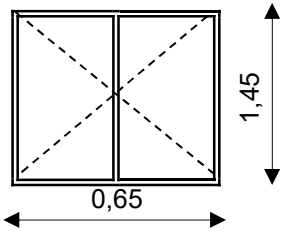
Lp.	Adres	Szkic okna	Ilość szt./ m <sup>2</sup>
c.d			
45.	UL. PODMIEJSKA 5		
	m 66		szt. - 1 2,80 m <sup>2</sup>  nawiewnik szt. - 1
	m 81		szt. - 1 4,13 m <sup>2</sup>
			szt. - 1 2,80 m <sup>2</sup>  nawiewnik szt. - 1
			szt. - 1 4,13 m <sup>2</sup>
46.	UL. POŁUDNIOWA 64		
	m 3		szt. - 1 0,94 m <sup>2</sup>

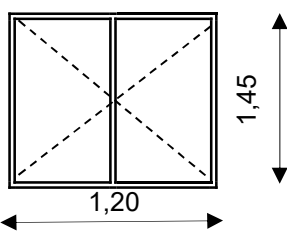
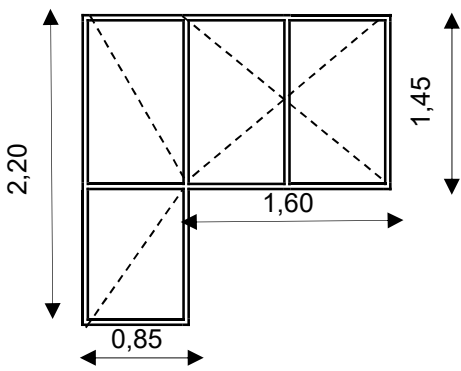
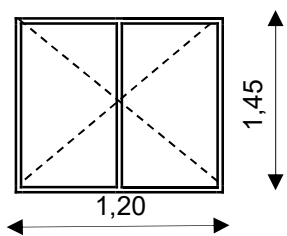
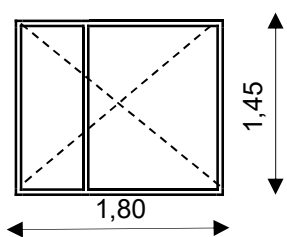
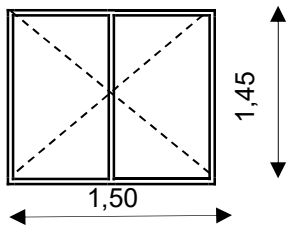
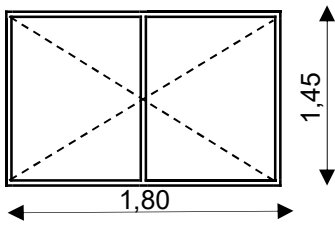
Lp.	Adres	Szkic okna	Ilość szt./ m <sup>2</sup>
c.d			
46	UL. POŁUDNIOWA 64		
m 3			szt. - 2 3,48 m <sup>2</sup>
			szt. - 1 4,19 m <sup>2</sup>
m 30			szt. - 1 1,74 m <sup>2</sup>
			szt. - 1 2,61 m <sup>2</sup>
47.	UL. POŁUDNIOWA 64A		
m 13			szt. - 2 4,35 m <sup>2</sup>
			szt. - 1 2,61 m <sup>2</sup>

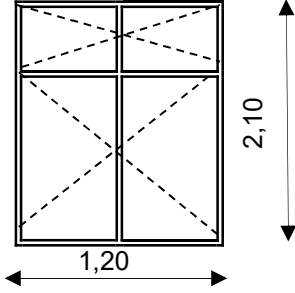
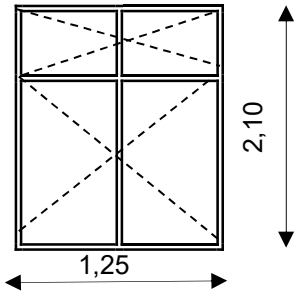
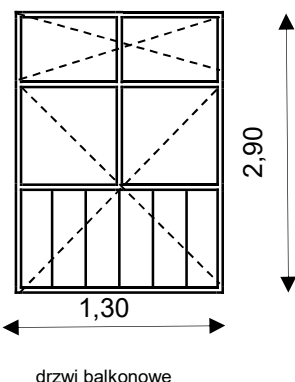
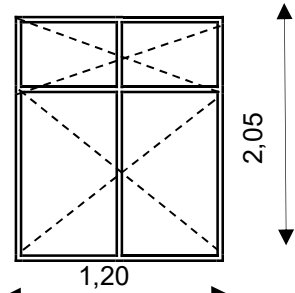
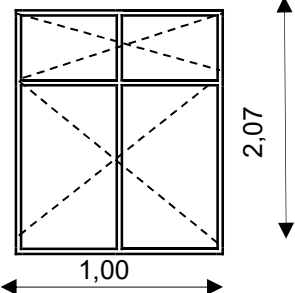

Lp.	Adres	Szkic okna	Ilość szt./ m <sup>2</sup>
48.	UL. PRZECHODNIA 4		
	m 2		szt. - 3 7,56 m <sup>2</sup>
	m 10		szt. - 2 5,25 m <sup>2</sup>
		 <p>drzwi balkonowe</p>	szt. - 1 3,77 m <sup>2</sup>
49.	UL. PUŁASKIEGO 7		
	m 15		szt. - 2 4,92 m <sup>2</sup>
			szt. - 3 6,21 m <sup>2</sup>

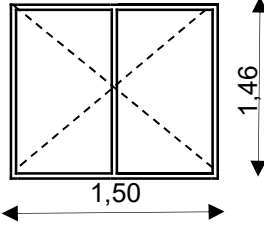
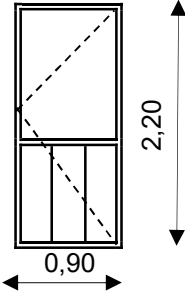
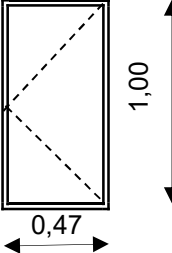
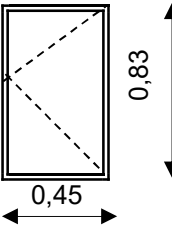
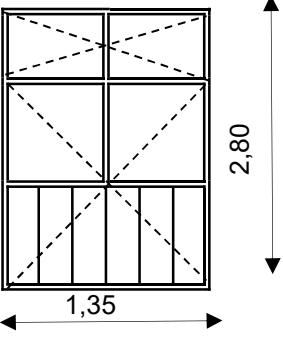
Lp.	Adres	Szkic okna	Ilość szt./ m <sup>2</sup>
50.	UL. SERBINOWSKA 9  m 51		szt. - 1 2,19 m <sup>2</sup>
51.	UL. STASZICA 21  m 3	 <p data-bbox="903 999 1040 1021">drzwi balkonowe</p>  	szt. - 1 1,98 m <sup>2</sup>  szt. - 2 0,94 m <sup>2</sup> nawiewnik szt. - 2  szt. - 1 0,37 m <sup>2</sup> nawiewnik szt. - 1
52.	UL. STAWISZYŃSKA 11  m 4	 <p data-bbox="935 2114 1072 2136">drzwi balkonowe</p>	szt. - 1 3,78 m <sup>2</sup>

Lp.	Adres	Szkic okna	Ilość szt./ m <sup>2</sup>
c.d			
52.	UL. STAWISZYŃSKA 11		
	m 4		szt. - 2 5,40 m <sup>2</sup>  nawiewnik szt. - 2
53.	UL. ŚRÓDMIEJSKA 16		
	m 19		szt. - 1 2,70 m <sup>2</sup>  nawiewnik szt. - 1
54.	UL. ŚRÓDMIEJSKA 35		
	m 17		szt. - 1 3,45 m <sup>2</sup>
55.	UL. TARGOWA 2-12A		
	m 1A		szt. - 1 2,08 m <sup>2</sup>
56.	UL. TUWIMA 12		
	m 1		szt. - 2 4,90 m <sup>2</sup>

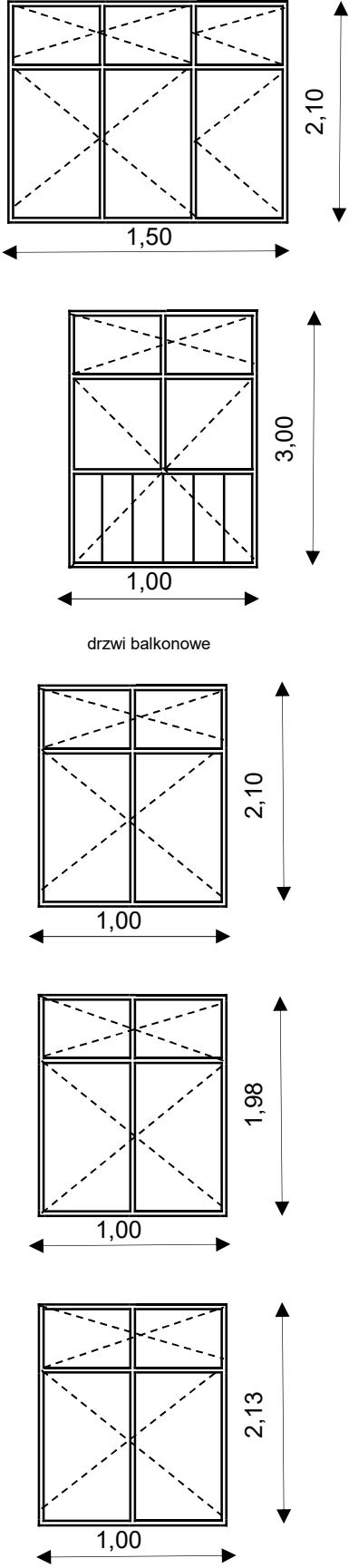
Lp.	Adres	Szkic okna	Ilość szt./ m <sup>2</sup>
57.	UL. ŻŁOTA 6		
m 1		 <p>The drawings show the following units and their specifications:</p> <ul style="list-style-type: none"> <li>Unit 1: A window with a width of 1,50 m and a height of 2,10 m. Area: 3,15 m<sup>2</sup>.</li> <li>Unit 2: A door labeled 'drzwi balkonowe' with a width of 1,00 m and a height of 3,00 m. Area: 3,00 m<sup>2</sup>.</li> <li>Unit 3: A window with a width of 1,00 m and a height of 2,10 m. Area: 2,10 m<sup>2</sup>.</li> <li>Unit 4: A window with a width of 1,00 m and a height of 1,98 m. Area: 1,98 m<sup>2</sup>.</li> <li>Unit 5: A window with a width of 1,00 m and a height of 2,13 m. Area: 2,13 m<sup>2</sup>.</li> </ul>	<p>szt. - 1 3,15 m<sup>2</sup></p> <p>szt. - 1 3,00 m<sup>2</sup></p> <p>szt. - 1 2,10 m<sup>2</sup></p> <p>szt. - 1 1,98 m<sup>2</sup></p> <p>szt. - 1 2,13 m<sup>2</sup></p> <p>nawiewnik szt. - 1</p>

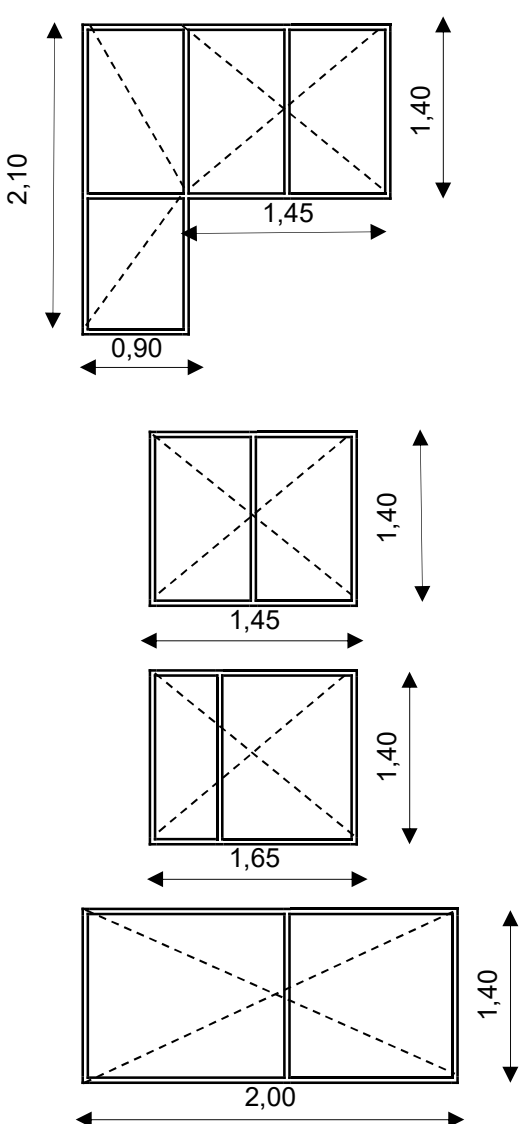
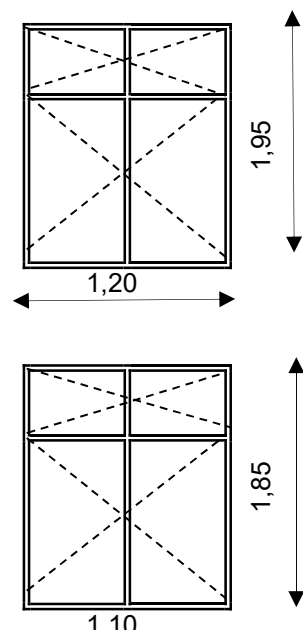
Lp.	Adres	Szkiec okna	Ilość szt./ m <sup>2</sup>
58.	UL. ŻŁOTA 26-28  m 13	 <p>The drawing shows four window units. The top unit is a large rectangle with a height of 2,10 and a width of 1,45. Below it are three smaller units: a square with side 1,45, a rectangle with width 1,65 and height 1,40, and a rectangle with width 2,00 and height 1,40. All units have dashed diagonal lines indicating panes.</p>	szt. - 1 3,92 m <sup>2</sup>  szt. - 1 2,03 m <sup>2</sup>  szt. - 1 2,31 m <sup>2</sup>  szt. - 1 2,80 m <sup>2</sup>
59.	UL. ŻŁOTA 33  m 24  m 36	 <p>The drawing shows two window units. The top unit has a width of 1,20 and a height of 1,95. The bottom unit has a width of 1,10 and a height of 1,85. Both units have dashed diagonal lines indicating panes.</p>	szt. - 5 11,70 m <sup>2</sup>  nawiewnik szt. - 1  szt. - 4 8,14 m <sup>2</sup>  nawiewnik szt. - 1

Lp.	Adres	Szkic okna	Ilość szt./ m <sup>2</sup>
60.	UL. WIDOK 13		
	m 1		szt. - 3 5,31 m <sup>2</sup>  nawiewnik szt. - 1
61.	UL. WODNA 2		
	m 47		szt. - 1 1,87 m <sup>2</sup>

Łączna ilość stolarki przewidzianej do wymiany :

**200 szt.**  
**466,54 m<sup>2</sup>**

Przewidywana ilość parapetów wewnętrznych :

**195 szt.**  
**292,81 mb**

Przewidywana ilość parapetów zewnętrznych :

**195 szt.**  
**292,81 mb**

Przewidywana ilość nawiewników powietrza :

**58 szt.**